

Whole House Water Softeners & Carbon Tank



WARNING

Please read carefully before proceeding with installation. Failure to follow any attached instructions or operating parameter may lead to the product's failure and possible damage to property.

SpectraPure® Inc. assumes no responsibility for water damage due to leaks. It is the user's responsibility to determine that the system is leak-free.

TABLE OF CONTENTS:

Thank You for your purchase of a SpectraPure® System. With proper installation and maintenance, this system will provide you with high quality water for years to come. All SpectraPure® products are rigorously tested by us for safety and reliability. If you have any questions or concerns, please contact our customer service department at 1.800.685.2783 or refer to our online troubleshooting at www.spectrapure.com.

Installation

PreInstallation Checklist	3
Installation for optional Carbon Tank	4-6
Installation for Water Softener and Brine Tank	7-8

Control Operation

Regeneration Valve Programming and Override Setup	9-11
---	------

Things you should know

Procedure for replacing water softener resin	12
Procedure for replacing media in carbon tank	13
Questions concerning salt in brine tank	14

Troubleshooting Guide

Troubleshooting problems and solutions	15-20
Warranty Coverage	21-22

 **WARNING:** Disconnect power at the main electrical box before installing or servicing the unit. Do not plug in unit or change fuses while standing on wet or damp surfaces and do not touch any other metal surfaces while plugging in product or changing fuses. Do it with one hand while keeping the other hand free.

Copyright © 2015 by SpectraPure Inc.
ALL RIGHTS RESERVED

No part of this publication may be reproduced, stored in a retrieval system, or transmitted in any form or by any means, electronic, mechanical, photocopying, recording or otherwise without the prior written permission of SpectraPure Inc.

PREINSTALLATION CHECK LIST FOR CARBON OR WATER SOFTENER:

- 1. **WATER PRESSURE:** A minimum of 25 lbs of water pressure is required for regeneration valve to operate effectively.
- 2. **ELECTRICAL:** An uninterrupted alternating current (A/C) supply is required. Please make sure voltage supply is compatible with unit before installation. **Make certain the electrical outlet is grounded by having it checked by an electrician or by using a UL Listed Circuit analyzer. Units are furnished with 3-prong grounded plugs to protect you against the possibility of electrical shock.** The outlet must be within reach of the power cord. Do not use an extension cord. Extension cords that are too

⚠ WARNING: Do not under any circumstances remove ground prong and never splice or cut the electrical cord.

long or too light do not deliver sufficient voltage to the unit and could present a safety hazard if the insulation were to become damaged. The receptacle should be located four (4) feet above the basement floor to guard against the possibility of immersion.

- 3. **PLUMBING:** Condition of existing plumbing should be free from lime and iron buildup. Replace piping that has heavy lime and/or iron build-up. If piping is clogged with iron, install a separate iron filter unit ahead of the water softener.

Perform all plumbing according to local plumbing codes.

- Use a 1/2" minimum pipe size for the drain.
- Use a 3/4" drain line for backwash flow rates that exceed 7 gpm or length that exceeds 20' (6 m).



When scale buildup is this bad, you must replace piping before installation of a water softener to prevent pipes from corrosion and possible leakage.

- 4. **LOCATION OF SOFTENER AND DRAIN:** Locate the softener close to a clean working drain and connect according to local plumbing codes.

⚠ CAUTION: DO NOT exceed 120 psi water pressure. DO NOT exceed 110° F water temperature. (Keep system away from extreme hot and cold temperatures.) DO NOT subject unit to freezing conditions.

Place the softener tank where you want to install the unit. If you have a carbon tank, you will install it in front of the water softener. Both the water softener and carbon tank will need a drain line.

NOTE: Be sure the tank(s) are level and on a firm base.

SAFETY INFORMATION

1. **Read instructions carefully and learn the specific detail regarding installation and use. Failure to do so could cause serious bodily injury and/or property damage.**
 2. **Check to be sure your power source is capable of handling the voltage requirements of the unit. Plug into a dedicated grounded receptacle which contains a fuse or circuit breaker of 20 amps or less.**
 3. **INSTALL WATER CONDITIONER IN AN AREA PROTECTED FROM FLOODING, RAIN, DIRECT SUNLIGHT, DUST, SNOW AND FREEZING. THE WARRANTY DOES NOT COVER DAMAGE INCURRED AS A RESULT OF EXPOSURE TO WEATHER.**
- * **All water treatment installations must conform to local plumbing, electrical and sanitation codes. These codes are established for your protection.**

INSTALLATION FOR OPTIONAL CARBON TANK:

INSTALLATION FOR CONTROL HEAD AND BYPASS VALVE:

(FOLLOW THESE STEPS BELOW AFTER YOU HAVE POSITIONED WHERE YOU WANT THE TANK (S) TO GO)

1. First, unscrew cap on top of Carbon Tank and remove the plug or tape off of the distributor tube. (Make sure that the distributor tube is flush with the top of the tank.)



2. Now, take the Control Head and the ByPass Valve and connect them together:
 - Lightly lubricate the o-ring seal on the ByPass Valve & Control Head. (NOTE: only use silicone lubricant.)
 - Remove the two metal screws that hold the clips in place. (Shown on page 5)
 - Position the two ports, as noted below, and secure bypass valve with the two metal clips to the control head (page 5). For now, leave the valve on "ByPass" mode.

BYPASS VALVE DESCRIPTION

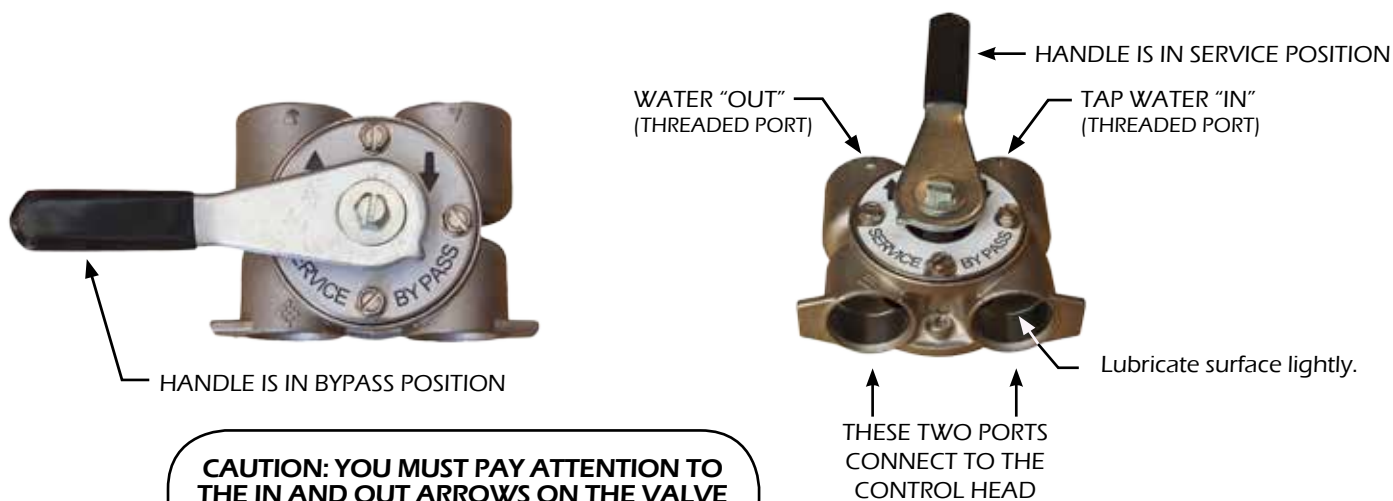

CAUTION: YOU MUST PAY ATTENTION TO THE IN AND OUT ARROWS ON THE VALVE TO BE SURE THAT IT IS PIPED PROPERLY.

3. Next, attach the collector screen to the lock connection and screw the control head onto the tank. (DO NOT over-tighten control head to tank. It does not need to be airtight.)
4. Connect the 3/8 drain line to the Back Wash connection on the back of the control head (see page 5). Connect this line to a drain pipe.
5. Turn on main water supply. Open a cold water faucet in the house and let water run a few minutes or until the system is free of foreign material (usually solder) resulting from the plumbing installation.

NOTE: If you are going to install a Water Softener after the Carbon Tank, follow steps 1-3 for installation of ByPass Valve on Softener Control Head, then proceed to page 7.

WARNING: If you are installing a Water Softener after the Carbon Tank, keep the WS valve in "ByPass" mode when doing step 4 AND when setting the startup procedure on page 6.

FRONT VIEW FOR CONTROL HEAD



BACK VIEW FOR CONTROL HEAD



NOTE: Install the Carbon Tank with the inlet, outlet and drain connections that meet applicable plumbing codes.

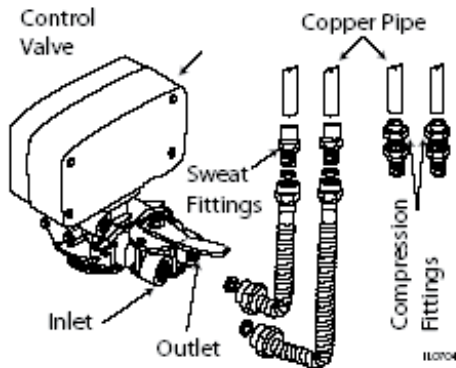

COLLECTOR SCREEN

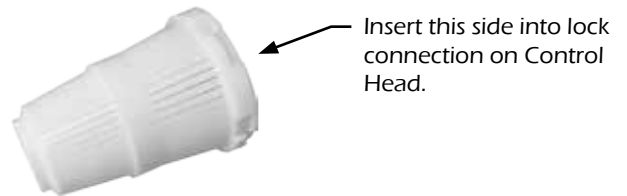

Plumbing components (as shown in picture) such as copper piping, braided tubing and fitting do not come with the water softener. They are readily available at any hardware store or your local plumber.

Perform all plumbing according to local plumbing codes.

- Use a 1/2" minimum pipe size for the drain.
- Use a 3/4" drain line for backwash flow rates that exceed 7 gpm or length that exceeds 20' (6 m).

INSTALLATION & STARTUP PROCEDURES FOR CARBON CONTROL HEAD:



Before Plugging electricity to the Unit:

1. Position ByPass Valve to "Service" mode and turn Regeneration Knob (clockwise) to the "In Service" position.
NOTE: The water flowing from the downstream tap is cloudy and/or contains media fines as well as air. Allow the water to run until it appears clean and free of air.
2. When a steady clean flow appears at the tap, close the tap and the main water supply valve and allow the filter media bed to settle for 15–20 minutes.
3. Manually index the filter to the "Backwash" position.
4. To prevent a sudden surge of water and air, partially open the main water supply valve so that the flow at the drain of the filter is approximately 1 gpm. The water at the drain is cloudy again and/or contains media fines as well as air. Allow water to flow at the drain until it appears clean and free of air.
5. Continue to open the water supply valve until it is completely open. Allow water to flow at the drain until all media fines are washed out of the filter.
6. Manually index the filter to the "In Service" position, and again open the downstream tap. Check to be sure that the water flows clear. If necessary, allow water to flow until all media fines are gone. If the tap is equipped with an aerator check that is not plugged with media fines and pipe scale.
7. Plug in the electrical cord and look in the sight hole on the back of the timer motor to ensure that it is running. Set the days back washing to occur by sliding tabs on the skipper wheel outward to expose trip fingers.
 - Each tab is one day.
 - Finger at red pointer is tonight.
 - Moving clockwise from red pointer, extend or retract fingers to obtain the desired backwash schedule.
8. Set time of day by pushing red button and spin the 24-hour gear until the present time of day is visible above the time of day arrow. The Carbon Control Head will count down until it needs to backwash. Backwash time is set to be from 2-3 AM. If you have a Water Softener installed after the Carbon tank, it too will want to regenerate at 2-3 AM. When the Carbon Tank and Water Softener backwash, they may over flood the drain line. To avoid this situation, you can trick the timer to backwash at different times by setting the time of day a few hours ahead or behind.

NOTE: Manually dial the various regeneration positions by turning the knob on the front of the control until the indicator shows that it is in the desired position.

INSTALLATION FOR CONTROL HEAD ON WATER SOFTENER:

FOLLOW THE STEPS BELOW AFTER YOU HAVE POSITIONED THE TANK(S) WHERE YOU WANT THEM TO GO

1. Follow steps 1-3 listed on page 4 for installation of ByPass Valve and Control Head.
2. If you installed a Carbon Tank in front of the Water Softener, keep its ByPass Valve in "service" mode.
3. (Make sure you leave the bypass valve, that is installed on the water softener head, on "bypass" for this step). Turn on the main water supply. Open a cold soft water tap nearby and let water run a few minutes or until the system is free of foreign material (usually solder) resulting from the plumbing installation. Close the water tap when water runs clean.



FLEX 5600SE Water Softener Head with collector screen

BRINE LINE CONNECTION FROM WATER SOFTENER CONTROL HEAD

4. Follow steps below on installation for Brine Tank and plug both valves into an approved power source. (FYI: When the valve has power it will drive the Bypass Valve to the "Service" mode.)

INSTALLATION FOR BRINE TANK:

1. Be sure that the floor under the Brine Tank is stable, clean and level.
2. Connect Brine Tube to compression nut fitting (diag on page 8) on both the Brine Tank and Control Head. (Located on the Safety Brine Valve and the side of the Control Head).
3. Place approximately 1" (25 mm) of water above the grid plate. If a grid is not utilized, fill to the top of the air check in the Brine Tank. (The air-check is a gray valve that is located inside the Brine Draw Tube at the bottom.)

NOTE: DO NOT ADD SALT OR POTASSIUM AT THIS TIME

4. Place the ByPass valve in "Service" mode and let water flow into brine tank. When water flow stops, slowly open a cold water tap nearby and let water run until air is purged.
5. Close tap.



LINE CONNECTION FROM WATER SOFTENER CONTROL HEAD

BRINE DRAW TUBE

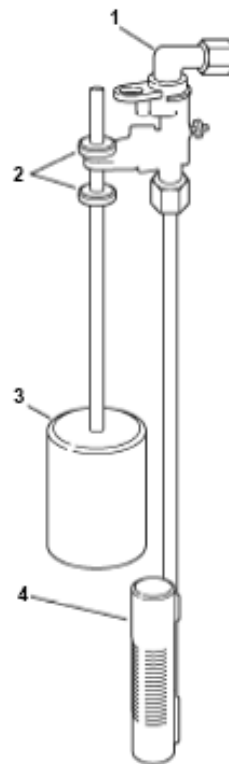

1. SAFETY BRINE VALVE
2. GROMMET
3. FLOAT ASSEMBLY
4. AIR-CHECK ASSEMBLY

WATER FLOW DIAGRAM FOR CARBON TANK AND WATER SOFTENER

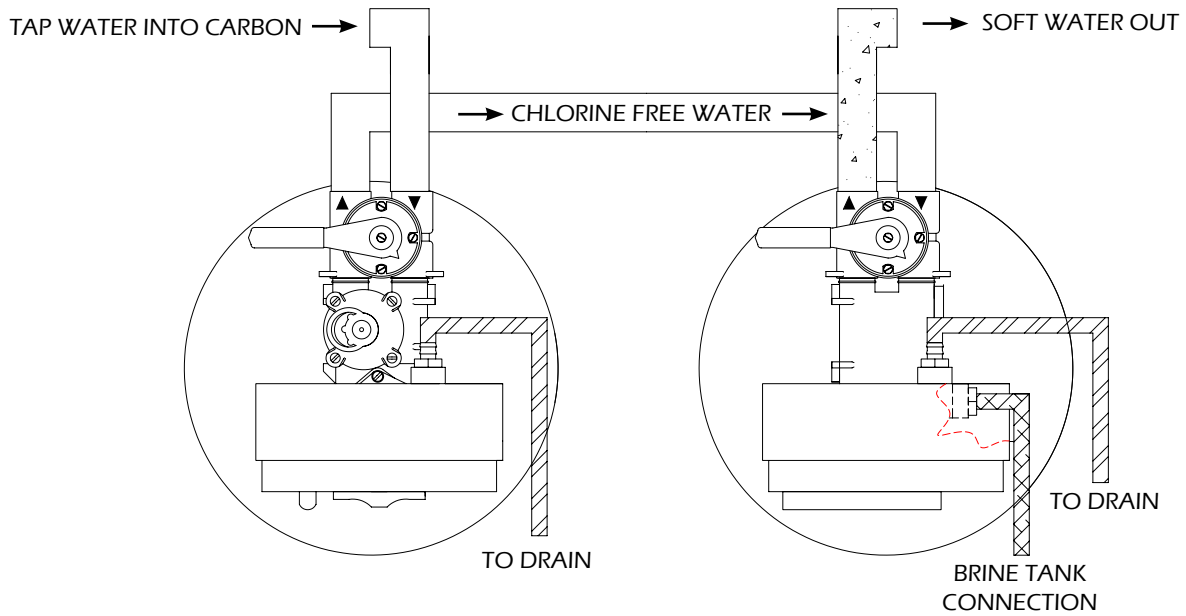

BRINE TANK DESCRIPTION

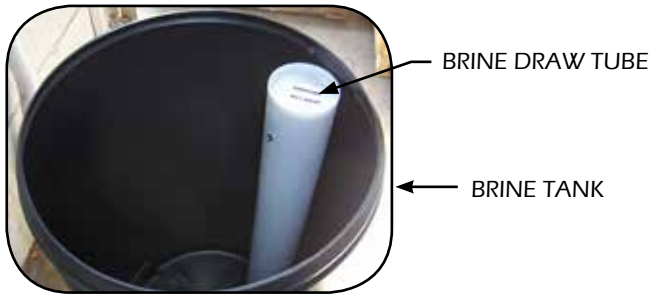

TANK CONNECTIONS

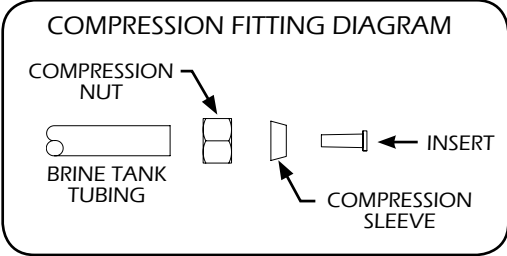
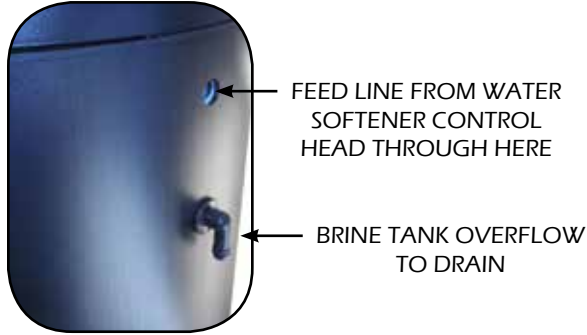

SpectraPure®

SET TIME OF DAY:

In normal operation the **Time of Day** display alternates with **Volume Remaining** display. As treated water is used, the Volume Remaining display counts down (in gallons) from a maximum value to zero or (- - -). Once this occurs, a regeneration cycle initiates immediately or delayed to the set **Regeneration Time**. Water flow through the valve is indicated by the flashing Flow Dot Indicator.

1. When the ByPass valve is in service mode, push either the SET UP or SET DOWN button once to adjust the time of day by one digit. Push and hold the adjust by several digits.

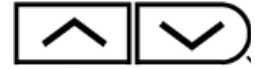

TIME OF DAY _____	IN SERVICE ●	12:00	● FLOW
	PROGRAM ○		○ P.M.
833 GALLONS OF TREATED WATER REMAINING _____	IN SERVICE ●	833	● FLOW
	PROGRAM ○		○ P.M.
0 GALLONS OF TREATED WATER REMAINING _____	IN SERVICE ●	- - -	● FLOW
	PROGRAM ○		○ P.M.

PROGRAMMING SETUP:

1. Push and hold both the SET UP and SET DOWN buttons for 5 seconds.
2. Set TREATED WATER CAPACITY: Using the SET UP or SET DOWN buttons, set the amount of treated water to flow through the unit before a regeneration is required.



650 GALLON CAPACITY _____	IN SERVICE ○	650	○ FLOW
	PROGRAM ●		○ P.M.

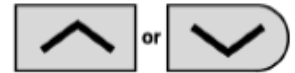

3. Push the EXTRA REGENERATION button.
4. Set the REGENERATION TIME: Use the SET UP or SET DOWN buttons to set the desired time of day for regeneration to occur.



2:00 A.M. _____	IN SERVICE ○	2:00	○ FLOW
REGENERATION TIME	PROGRAM ●		○ P.M.

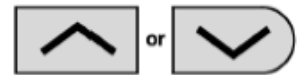

5. Push the EXTRA REGENERATION button.
6. Set the REGENERATION DAY OVERRIDE: Use the SET UP or SET DOWN buttons to set the maximum number of days before a regeneration cycle must occur.



REGENERATION EVERY _____	IN SERVICE ○	A- -7	○ FLOW
7 DAYS MINIMUM	PROGRAM ●		○ P.M.

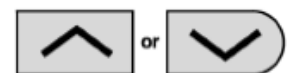



7. Push the EXTRA REGENERATION button to exit the program

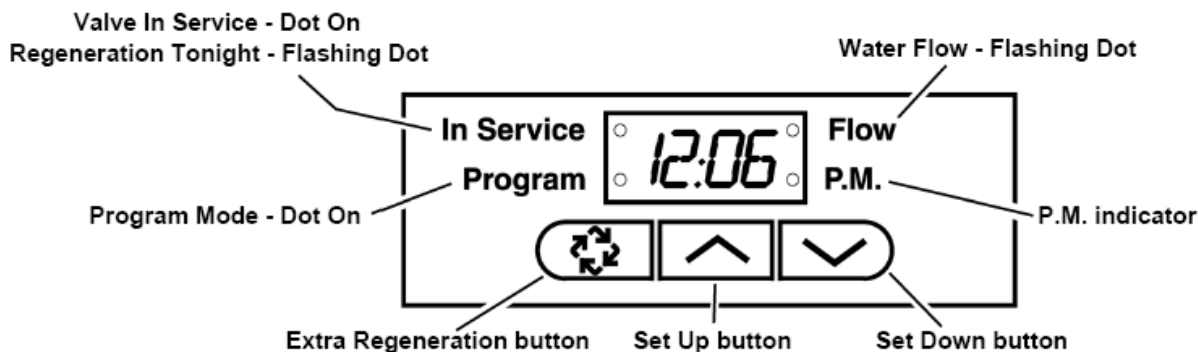

FAST REGENERATION CYCLE:

Perform the following Fast Cycle Regeneration if setting up the system for the first time.



1. Push the Extra Regeneration button for 5 seconds to force an extra regeneration immediately. 
2. Once the valve reaches Regeneration, step 1, let water run to drain for approximately 5 minutes.
3. Push the Extra Regeneration button once to advance valve to Regeneration, step 2.
4. Push the Extra Regeneration button once to advance valve to Regeneration, step 3 (if active).
5. Push the Extra Regeneration button once to advance valve to Regeneration, step 4 (if active).
6. Push the Extra Regeneration button once to advance valve to Regeneration, step 5 (if active)
7. Push the Extra Regeneration button once more to advance the valve back to In Service.

FINAL SETUP: (With proper valve operation verified)

1. Manually step the valve to the Brine Draw position and allow the valve to draw water from the brine tank until it stops.
NOTE: The air check will check at approximately the midpoint of the screened intake area.
2. Manually step the valve to the Brine Refill position and allow the valve to return to the In Service position automatically.
3. With the valve in the Service position, check that there is approximately 1" (25 mm) of water above the grid in the brine tank, if used.
4. Fill the brine tank with salt.
5. Setup is complete, the control can now run automatically.

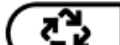
FYI: You can start an extra regeneration cycle immediately by pushing and holding down on  for 5 seconds. If you want to start an extra regeneration tonight, push  once.

CONTROL OPERATION:

Immediate Regeneration Valves with Days Between Regeneration Override Set

When the valve reaches its set Days Since Regeneration Override value, a regeneration cycle initiates immediately. This event occurs regardless of the Volume Remaining display having reached zero gallons.

Delayed Regeneration Valves With Days Between Regeneration Override Set

When the valve reaches its set Days Since Regeneration Override value a regeneration cycle initiates at the preset Regeneration Time. This event occurs regardless of the Volume Remaining display having reached zero gallons.

Control Operation During Regeneration

In Regeneration the control displays a special Regeneration display. In this display the control shows the current regeneration step number the valve is advancing to, or has reached, and the time remaining in that step. The step number that displays flashes until the valve completes driving to this regeneration step position. Once all regeneration steps are complete the valve returns to In Service and resumes normal operation. Pushing the Extra Cycle button during a Regeneration cycle immediately advances the valve to the next cycle step position and resumes normal step timing.

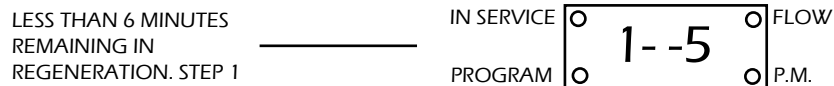

Control Operation During Programming

The control only enters the Program Mode with the valve In Service. While in the Program Mode the control continues to operate normally monitoring water usage and keeps all displays up to date. Control programming is stored in memory permanently. There is no need for battery backup power.

Control Operation During A Power Failure

During a power failure all control displays and programming are stored for use upon power re-application. The control retains these values for years, if necessary, without loss. The control is fully inoperative and any calls for regeneration are delayed. The control, upon power re-application, resume normal operation from the point that it was interrupted. An indication that a power outage has occurred is an inaccurate Time Of Day display.

THINGS YOU SHOULD KNOW :

1. Water Softener resin should last between 15-20 years. Below is the procedure on replacing the resin:

a. Disconnect the Control Head from your tap water plumbing. Unscrew the Control Head from the water softener and empty the resin into a trash can. (You will need more than one person to do this).

b. Once the resin is removed, wash the tank clean and insert the distributor tube. (The distributor tube should be placed in the softener or carbon tank with the lower collector screen basket end down). Turn the tube a couple times to make sure that the bottom basket seats properly in the bottom of the tank. Make sure the distributor tube is in the tank **BEFORE YOU ADD THE RESIN or CARBON!**

c. Cover the open upper end of the distributor tube with tape or a cap (as shown) to keep any resin from falling into the distributor tube while pouring the resin into the tank. ***Remove the tape after filling the tank.***



d. Place the funnel into the softener tank (as shown), and slowly pour the resin into the softener tank.

CAUTION: If you *purchased a water softener that came with a bag containing gravel, you must add the gravel first before the resin. You will need enough gravel to completely bury the collector screen.*



e. **Be careful to keep the distributor tube centered as best you can, while filling.** Once the filling of the softener tank is completed, carefully remove the tape or cap from the distributor tube. Do not pull upwards on the distributor tube. *(If you do pull on the tube you will have to reposition it by blowing compressed air in the hole and pushing it back down to position).*

f. The control valve head can now be screwed back onto the softener tank. Be sure the large O-ring is in place, and lubricated. As you start to screw the control valve onto the tank, make sure the hole in the center of the control valve fits over the distributor tube (page 13). The control valve should be hand tightened, snug and tight to eliminate a possible leaks.

NOTE: Our Water Softeners do not come with a gravel bed because the tank is set up as downflow. Downflow means that the water passes through the resin first and is sucked up through the distributor tube.

(continued on next page)

2. Carbon Tank media should last between 2-6 years. Below is the procedure on replacing the carbon.

- a. Follow steps a-c on page 12.
- b. Fill the empty carbon tank with approximately 2 gallons of water.
- c. Place the distributor tube into the tank and keep centered. Tape the end.
- d. Pour in enough gravel to completely bury the collector screen.
- e. Place the funnel into the tank (as shown), and slowly pour the carbon into the softener tank. You will need to add a specific amount of carbon to the tank which depends on what size tank you have.



Tank Sizes:

9" x 48" = 1 cu ft of Carbon

10" x 54" = 1.5 cu ft of Carbon

2" x 52" = 2.1 cu ft of Carbon

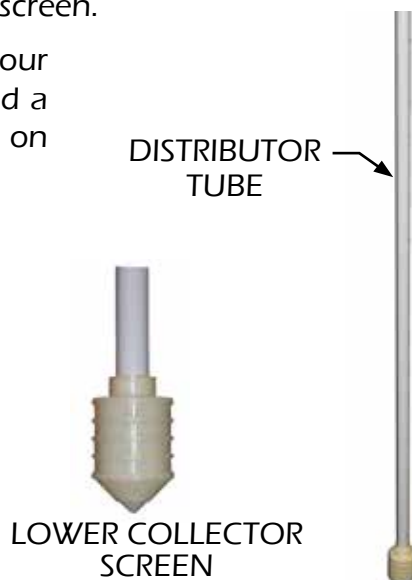

- f. Be careful to keep the distributor tube centered as best you can, while filling. Once the filling of the carbon tank is completed, carefully remove the tape or cap from the distributor tube. Do not pull upwards on the distributor tube. *(If you do pull on the tube you will have to reposition it by blowing compressed air in the hole and pushing it back down to position.)*
- g. The control valve head can now be screwed back onto the carbon tank. Be sure the large O-ring is in place, and lubricated. As you start to screw the control valve onto the tank, make sure the hole in the center of the control valve fits over the distributor tube. The control valve should be tightened by hand in a clockwise direction until it is snug and tight to eliminate a possible leaks.
- h. BEFORE YOU TURN ON THE WATER TO THE CARBON TANK, MAKE SURE YOU HAVE THE WATER SOFTENER'S "BYPASS" VALVE ON BYPASS MODE.
 - Turn on the main water supply with the water softener on bypass.
 - Open a cold water faucet in the house and let the water run through the carbon tank for a few minutes or until the water runs clear.

NOTE: A carbon tank must have a gravel bed because the tank is set up as upflow. Upflow means that the water passes through the distributor tube first, then through the gravel bed and finally through the carbon. The gravel bed helps to disperse the water evenly through the carbon.

(continued on next page)

3. When do I add Salt, and how much should I add?:

Add salt whenever the water level in the Brine Tank is higher than the salt level. A brine tank is designed to be filled to the top with sodium or potassium chloride.

4. What is "mushing" and why do I need to avoid it?:

When salt pellets or cube-style salt is used, it may form tiny crystals of salt. The crystals might bond, creating thick masses in the brine tank. This is called "mushing" and may interrupt the brine production. If this happens, a water softener may not be able to produce soft water.

5. Is softened water harmful to a septic system?:

NO. Back washing or Regeneration water does not cause any harm to the septic system.

6. The Sodium that is used, is it harmful to my health?:

NO. Many people don't realize but the research discussed with salt and its effects on a person's health is usually referred to sodium chloride, and not sodium bicarbonate, which is the result of softening. Sodium Free alternatives are available:

- Potassium Chloride rather than Sodium Chloride can be used. Potassium-based crystals can be used directly in the brine tank of your current Water Softener.
- Connect the Water Softener to only the hot water line. This will make it possible to drink and cook with unsoftened water.
- Install a Whole House Reverse Osmosis System. Gives you full benefits of water purification technologies. (This method is best used with PVC piping throughout the house or an alternative RO Custom system) Please call for more Information on this subject.



7. What size water softener do I need?:

Ask yourself this question.. What amount of hardness is contained in your tap water? You can measure your hardness content by using a Hardness Test Kit. There are some simple calculations you can do as well:

- a. Calculate how much water your household goes through: Multiply the number of people in your family by 75. (the #75 is an estimate number of gallons of water used per person per day.)
- b. Find the GPG (Gallons Per Grain) hardness of your water. (20 GPG is common in most areas). Use a hardness test kit.
- c. Multiply the water usage by the GPG. Example: for a 4 person household, in an area with GPG of 20: $4 \times 75 = 300$, then $300 \times 20 = 6,000$ GPG Total Hardness Per Day.

NOTE: It is recommended that the softener has enough capacity to last approximately 3 days between regeneration of the resin. A typical household capacity for the Softener is about 20,000-40,000 grains. Example: A 4-person household, over a 3 day period, 18,000 grains would pass through the softener. Therefore a resin capacity of 20,000 grains would meet your household needs.

TROUBLESHOOTING:

PROBLEM	CAUSE	CORRECTION
1. Softener fails to regenerate	<ul style="list-style-type: none"> A. Electrical service to unit has been interrupted. B. Timer is defective. C. Power failure 	<ul style="list-style-type: none"> A. Assure permanent electrical service (check fuse, plug, pull chain of switch). B. Replace timer. C. Reset time of day.
2. Softener delivers hard water.	<ul style="list-style-type: none"> A. Bypass Valve is open. B. No salt in brine tank. C. Injectors or screen plugged. D. Insufficient water flowing into brine tank. E. Hot water tank hardness. F. Leak at distributor tube. G. Internal valve leak. 	<ul style="list-style-type: none"> A. Close bypass valve. B. Add salt to brine tank and maintain salt level above water level. C. Replace injectors and screen. D. Check brine tank fill time and clean brine line flow control if plugged. E. Repeat flushing for the hot water tank is required. F. Make sure distributor tube is not cracked. Check O-ring & tube pilot. G. Replace seals and spacers and/or piston.
3. Unit uses too much salt.	<ul style="list-style-type: none"> A. Improper salt setting. B. Excess water in brine tank. 	<ul style="list-style-type: none"> A. Check salt usage and salt setting. B. See Problem 7.
4. Loss of water pressure.	<ul style="list-style-type: none"> A. Iron buildup in line to softener. B. Iron buildup in water softener. C. Inlet of control plugged due to foreign material loose from pipes by recent work done on plumbing. 	<ul style="list-style-type: none"> A. Clean line to water conditioner. B. Clean control and add resin cleaner to resin bed. Increase frequency of regeneration. C. Remove piston and clean control.
5. Loss of resin through drain line.	<ul style="list-style-type: none"> A. Air in water system. 	<ul style="list-style-type: none"> A. Assure that well system has proper air elimination control. Check for dry well condition.
6. Iron in conditioned water.	<ul style="list-style-type: none"> A. Fouled resin bed. 	<ul style="list-style-type: none"> A. Check backwash, brine draw and brine tank fill; increase frequency of regeneration; increase backwash time.
7. Excessive water in brine tank.	<ul style="list-style-type: none"> A. Plugged drain line flow control. 	<ul style="list-style-type: none"> A. Clean flow control.
8. Salt water in service line.	<ul style="list-style-type: none"> A. Plugged injector system. B. Timer not cycling. C. Foreign material in brine line. D. Foreign material in brine flow control. 	<ul style="list-style-type: none"> A. Clean injector and replace screen. B. Replace timer. C. Clean or replace brine valve. D. Clean brine line flow control.

TROUBLESHOOTING (continued):

PROBLEM	CAUSE	CORRECTION
9. Softener fails to draw brine.	<ul style="list-style-type: none"> A. Draw line flow control is plugged. B. Injector is plugged. C. Injector screen plugged. D. Line pressure is too low. E. Internal control leak. 	<ul style="list-style-type: none"> A. Clean drain line flow control B. Clean or replace injectors. C. Replace screen. D. Increase line pressure (min. 30 psi). E. Change seals, spacers and/or piston assembly.
10. Control cycles continuously.	<ul style="list-style-type: none"> A. Faulty timer mechanism. 	<ul style="list-style-type: none"> A. Replace timer.
11. Drain flows continuously.	<ul style="list-style-type: none"> A. Foreign material in control. B. Internal control leak. C. Control valve jammed in Brine or Backwash position. D. Timer motor stopped or jammed. 	<ul style="list-style-type: none"> A. Remove piston assembly and inspect bore; remove foreign material and check control in various regeneration positions. B. Replace seals and/or piston assembly. C. Replace seals and/or piston assembly. D. Replace timer.

GENERAL SERVICE "HINTS" FOR METER CONTROL (if meter controller is used for water softener)

PROBLEM	CAUSE	CORRECTION
1. Softener delivers hard water.	<ul style="list-style-type: none"> A. Reserve capacity has been exceeded. B. Program wheel is not rotating with meter output. C. Meter is not measuring flow. 	<ul style="list-style-type: none"> A. Check salt dosage requirements and reset program wheel to provide additional reserve. B. Pull cable out of meter cover and rotate manually. Program wheel must move without binding and clutch must give positive "clicks" when program wheel strikes regeneration stop. (If not, replace timer.) C. Check output by observing rotation of small gear on front of timer. (Program wheel must not be against regeneration stop for this check.) Each tooth is approximately 30 gallons. (If not, replace meter.)
2. Filter fails to backwash.	<ul style="list-style-type: none"> A. Electrical service to unit has been interrupted. B. Timer is defective. C. Power failure. 	<ul style="list-style-type: none"> A. Assure permanent electrical service. (Check fuse, plug, pull chain or switch.) B. Replace timer. C. Reset time of day.

TROUBLESHOOTING (continued):

PROBLEM	CAUSE	CORRECTION
3. Filter "bleeds" iron.	<p>A. Bypass Valve is open.</p> <p>B. Excessive water usage.</p> <p>C. Hot water tank is rusty.</p> <p>D. Leak at distributor line.</p> <p>E. Defective or stripped filter medium bed.</p> <p>F. Inadequate backwash flow rate.</p>	<p>A. Close bypass valve.</p> <p>B. Reduce days between backwashing. (See timer instructions.) Make sure that there are no leaking valves in the toilet bowl or sinks.</p> <p>C. Repeated flushing of the hot water tank is required.</p> <p>D. Make sure distributor tube is not cracked. Check O-ring and tube pilot.</p> <p>E. Replace bed.</p> <p>F. Make sure filter has correct drain flow control and that the flow control is not clogged or drain line restricted. Check that the water pressure has not dropped. Increase backwash flow rate according to specifications for your unit. See your dealer for recommendations.</p>
4. Loss of water pressure.	<p>A. Iron or turbidity buildup in water filter.</p> <p>B. Inlet plugged due to foreign material broken loose from pipes by recent plumbing work.</p>	<p>A. Reduce days between backwashing so filter backwashes more often. Make sure filter is sized large enough to handle water usage.</p> <p>B. Remove piston and clean control.</p>
5. Loss of filter medium through drain line.	<p>A. Broken or missing top screen.</p>	<p>A. Replace top screen. The top screen must have 0.020" wide slots.</p>
6. Drain flows continuously.	<p>A. Foreign material in control.</p> <p>B. Internal control leak.</p> <p>C. Control valve jammed in rinse or backwash.</p>	<p>A. Remove piston assembly and inspect bore. Remove foreign material and check control in various cycle positions</p> <p>B. Replace seals and/or piston assembly.</p> <p>C. Replace piston, seals and spacers (and drive motor, if necessary).</p>

- CYCLE TIMES for WATER SOFTENER - (for further information and servicing, please refer to manufacture's manual).

SERVICE POSITION:
Standard operation

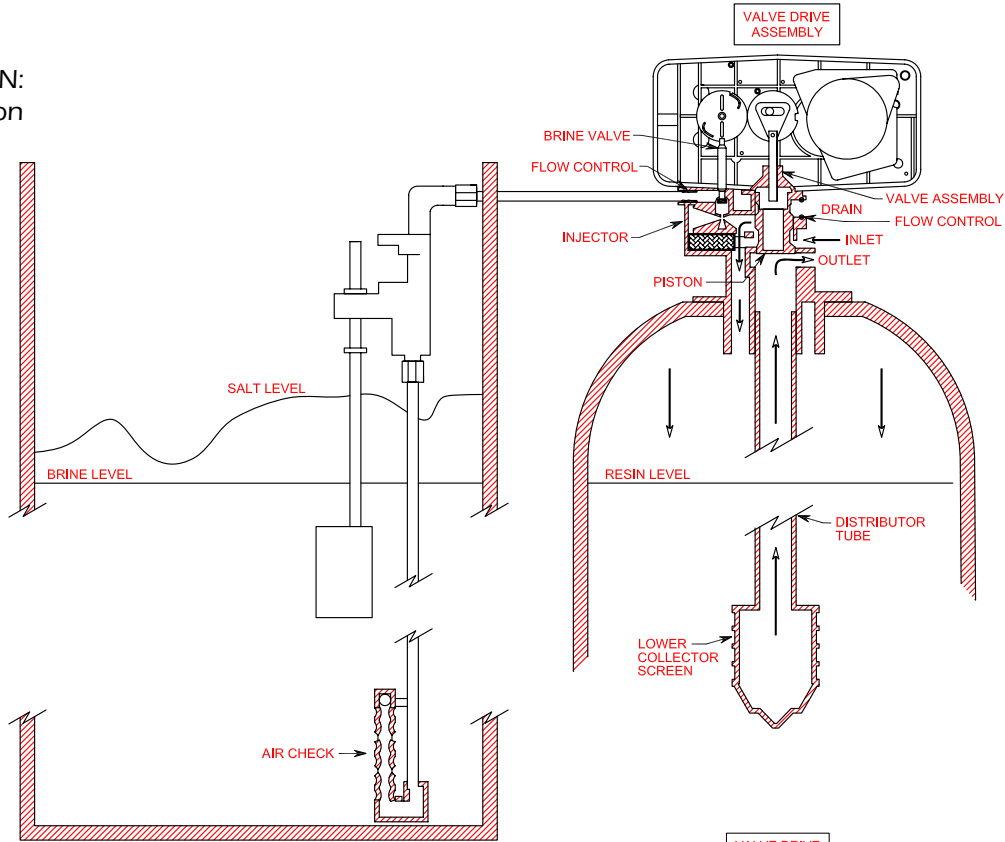

BACKWASH POSITION:
With standard filter piston, 10 min.

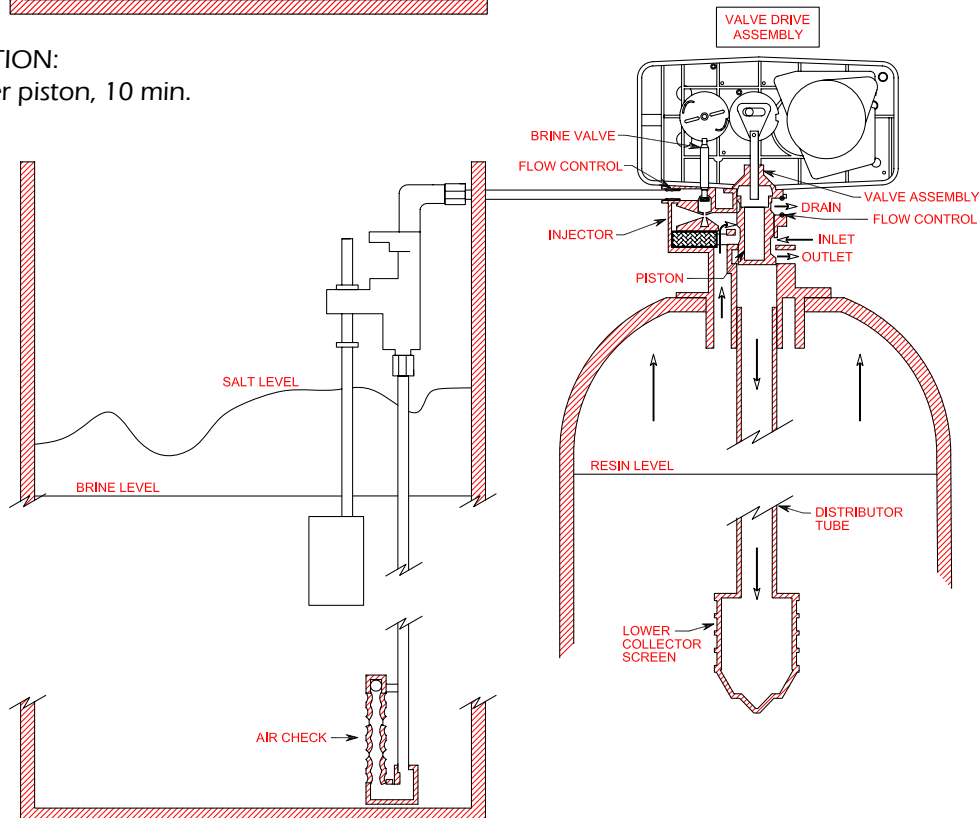

BRINE / SLOW RINSE POSITION:

This cycle eliminates brine solution in resin tank. 60 minute pause. (No water flows during this time)

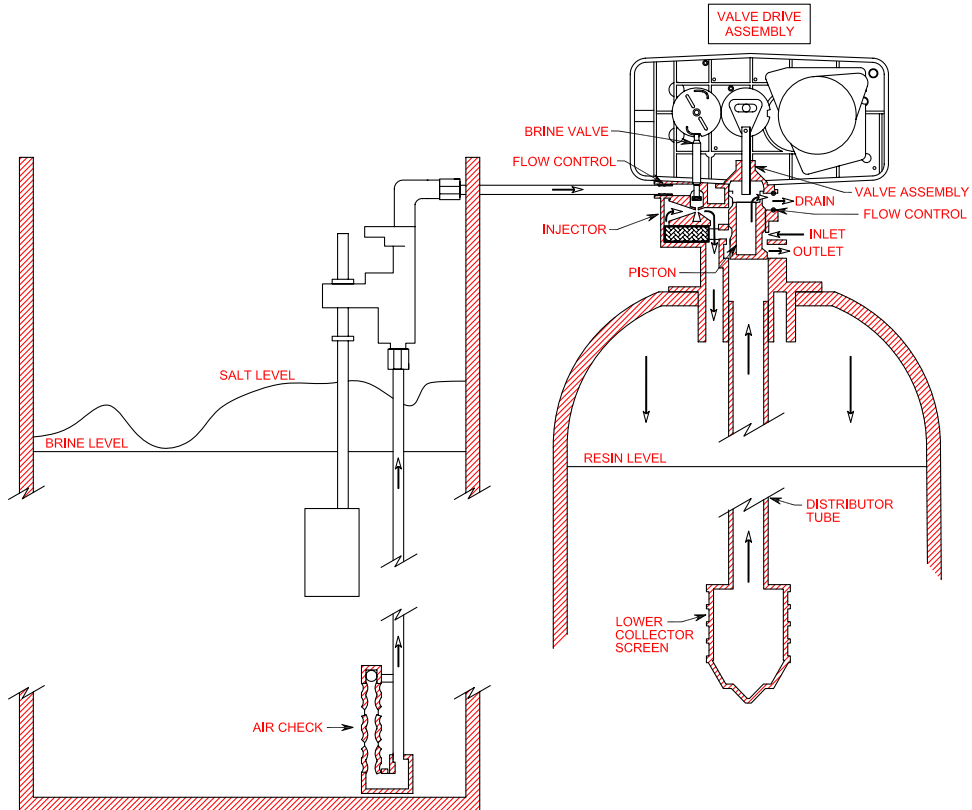

SECOND BACKWASH POSITION (Double Backwash Units Only):

With standard filter piston, 10 min.

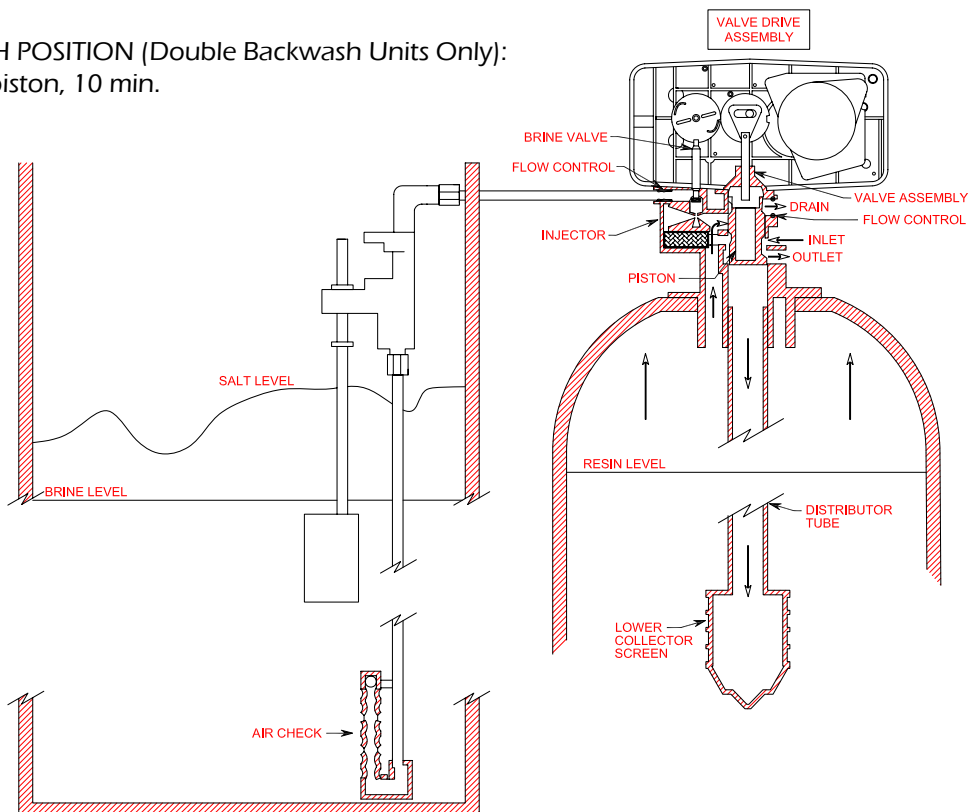

FINAL, RAPID RINSE

5-10 minutes, depending on house pressure.

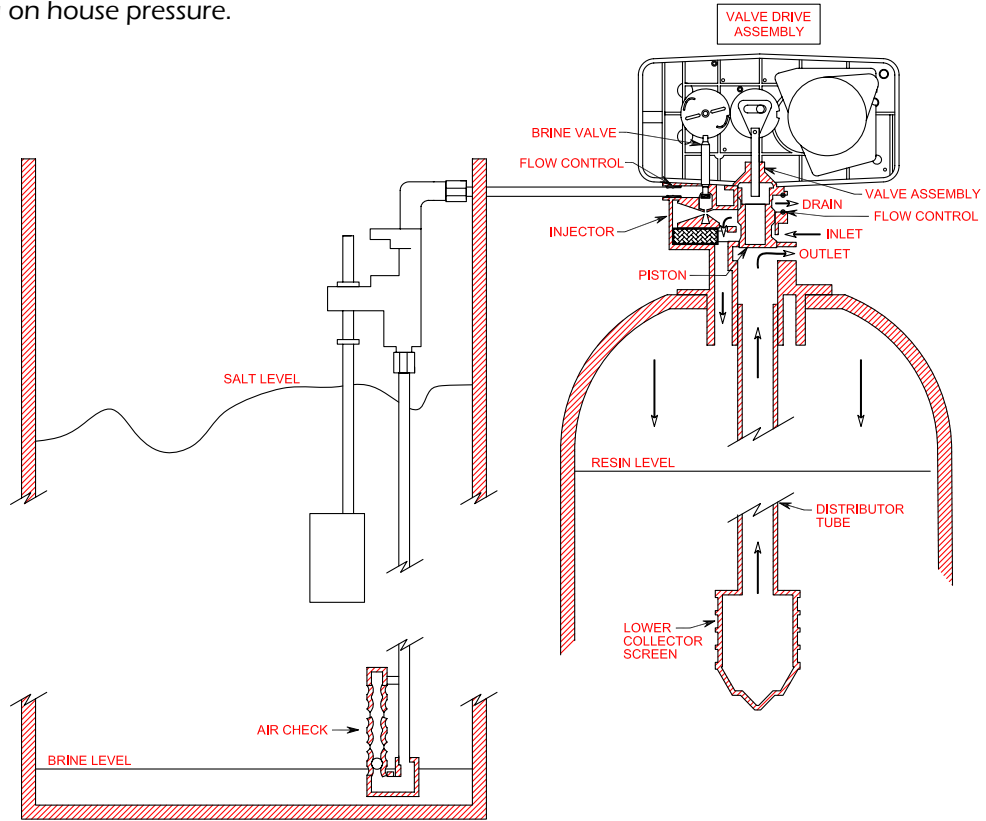

BRINE TANK REFILL POSITION

5-10 minutes, depending on house pressure.

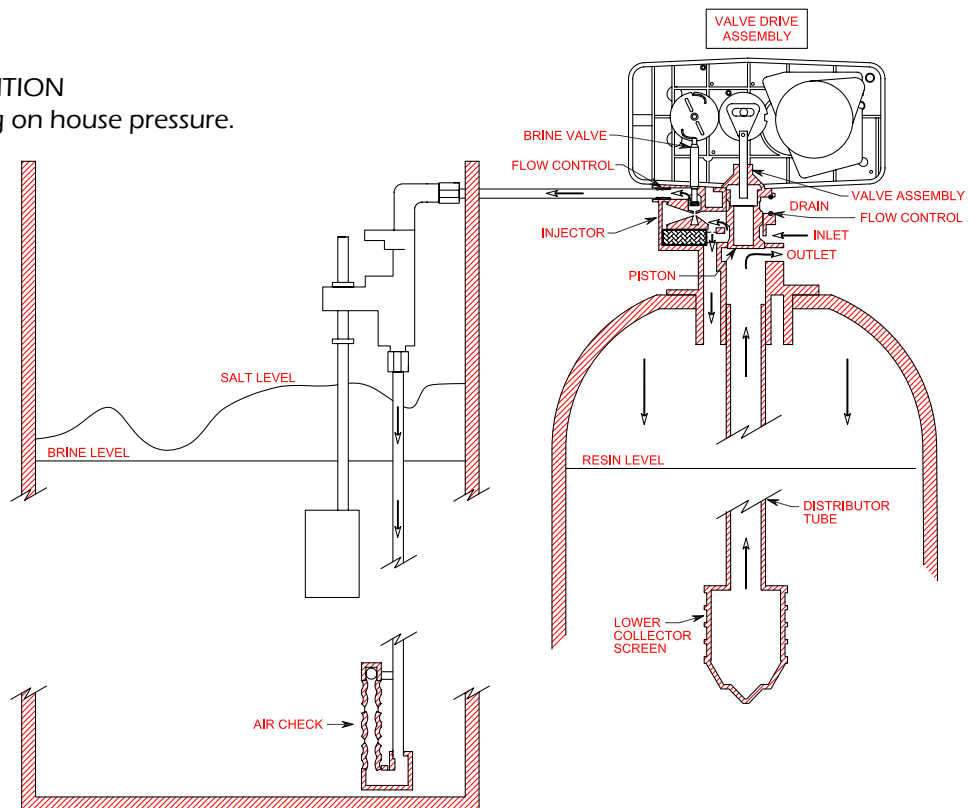

SpectraPure®

WARRANTY COVERAGE:

*- THIS WARRANTY IS EFFECTIVE TO ORIGINAL PURCHASER AT THE ORIGINAL INSTALLATION SITE -
(Some states do not allow limitations on how long an implied warranty lasts, so the above limitations may not apply to you. This warranty gives you specific legal rights, and you may also have other rights, which vary from state to state).*

Limited Warranty:

SpectraPure Inc. warrants to the original consumer purchaser that the water conditioning systems specified below by model and serial number, and the parts listed in this section below, will be free from DEFECTS IN MATERIAL AND WORKMANSHIP from the date of purchase for the following periods:

- For 10 years to original purchaser & original address ----- Fiberglass pressure vessel
- For a period of 5 years ----- Valve body, internal valve parts, timer assembly, brine tank, distributor

No sales representative, distributor, dealer or other person is authorized to make any other warranty on behalf of the manufacturer. Upon expiration of the applicable warranty periods, the manufacturer shall have no further liability related to the products to which the periods apply, except with respect to warranty claims asserted during the appropriate warranty period.

- Installation -

This warranty does not cover installation or damage to tanks resulting from direct sunlight, mishandling, improper installation, water pressure less than 30 psi or in excess to 80 psi, freezing or water temperatures in excess of 120° F. Hot water back up or vacuum damage is not covered. Warranty must be presented at time of claim to the person or persons performing the repair work in order to honor warranty parts.

- Labor Charges -

Labor charges incurred in connection with repair and/or replacement of parts, tanks or water conditioning units are expressly excluded from this warranty.

- Transportation fees -

All transportation and freight costs in connection with the repair and/or replacement of parts, tanks or water conditioning systems are also expressly excluded from this warranty.

This warranty does not cover failures or defects that are the result of misuse, mishandling, misapplication, neglect, accident, damaged caused by fire, flood, acts of God or any other casualty, abuse or degradation from iron, oxidation due to chlorine, mold due to leaks, alteration of product or the adjustment or repair performed by anyone other than the manufacturer or one of the manufacturer's authorized agents, or where the water conditioner has not been installed in compliance with local plumbing codes and ordinances.

Some states do not allow the exclusion or limitation of incidental or consequential damages, so the above limitations or exclusion may not apply to you.

As soon as the purchaser discovers any defect or failure, the purchaser must within the period of the applicable warranty notify SpectraPure Inc. of that defect. The purchaser must then return the defective part or item with all transportation charges prepaid to SpectraPure Inc.

Information regarding warranty performance may be obtained by writing to: SpectraPure, Inc
2167 East 5th St.
Tempe, AZ 85281

DATE SOLD TO CUSTOMER: _____

MODEL: _____

SERIAL NUMBER: _____

- JOB SPECIFICATION INFO -

JOB SITE ADDRESS: _____

MODEL NUMBER: _____

WATER TEST (Hardness): _____

CAPACITY OF UNIT _____ Max: _____ Per Regeneration

UNDER BEDDING: _____ Amount: _____

MINERAL TANK SIZE (Diameter): _____ Hight: _____

TYPE OF MEDIA: _____ Cubic Feet: _____

BRINE TANK SIZE: _____

SALT SETTING PER REGENERATION: _____

- VALVE PROGRAMMING -

TREATED WATER CAPACITY (Gallons / Liters): _____

REGENERATION DAY OVERRIDE (Max. Days Between Regen.): _____

REGENERATION TIME (AM/PM) : _____